

VertHex Solar Street Light



Superior
Outdoor LED



Efficient MPPT
Controller



LiFePO4
Battery



Robust
Structure



IP66
Waterproof



A Variety of LED Street Lights and accessories combination

As another outstanding product from Leadsun, the VertHex Solar Power System boasts versatile applications, compatible with a variety of lighting fixtures and battery combinations. It can be used in conjunction with Leadsun's Freedom Classic and Freedom Plus street lights, as well as Bell-shaped and V-shaped street lights, accommodating various battery configurations (with independent controllers or built-in controllers). These systems are highly suitable for a wide range of project scenarios and requirements.



Mind Mapping



Vertical Solar Panel 1~2



MPPT Controller 3

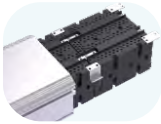

MPPT Controller with Battery (Optional) 4~5



LiFePO4 Battery Pack (Optional) 6



Freedom Classic LED Street Light 7~8



Freedom Plus LED Street Light 9~10



XL series Bell-shaped LED Street Light 11~12



V-shaped Luminaire 13~14

VertHex Solar Power System

PRODUCT FEATURES

- 360° sunlight reception**
Cylindrical design captures sunlight from all directions.
- Leadsun MPPT controller**
Power generation efficiency is about 40% higher than that of PWM controller.
- Durable Aluminum Frame**
Superior corrosion resistance and mechanical strength.
- Vertical installation**
Less wind resistance, helps reduce light pole costs, prevents fallen leaves, dust, rain and snow buildup.
- Flexible use**
Can be used with a variety of luminaires and battery configurations.
- Wide application**
Ideal for street lights, monitoring systems, and other outdoor electrical equipment power supplies.

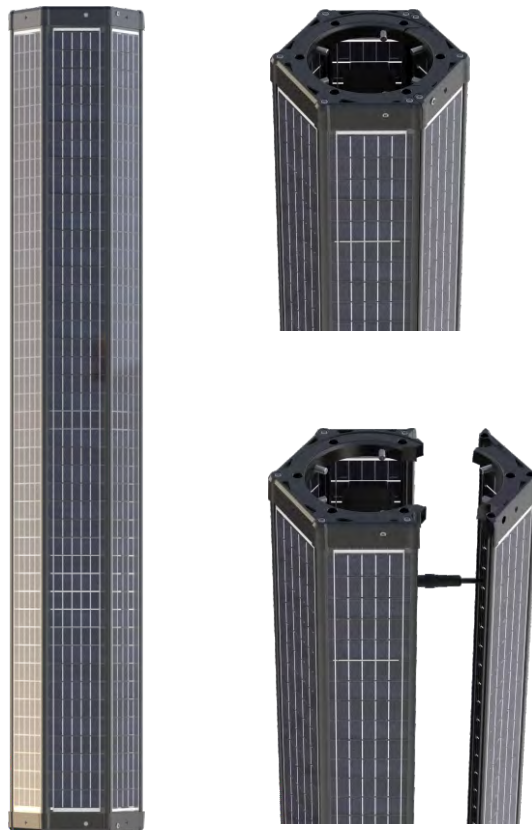

PHYSICAL DIMENSIONS (mm)

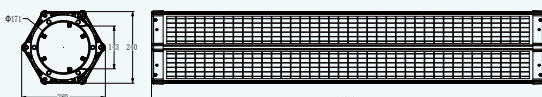

VSPV150W22-280

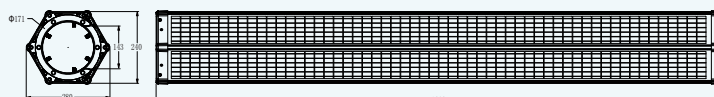

VSPV230W38-280

PRODUCT ADVANTAGES

- High efficiency and safety**
Power station-grade monocrystalline solar cell efficiency >23%.
MPPT controller operates efficiently in early morning, dusk and cloudy weather.
Well-protected against back charging, over current, over voltage, over temperature, etc.
- Better integration**
Well integrated with the light pole, has good heat dissipation performance and looks more technological.
- PV panels working independently**
Ensure uninterrupted operation of other panels in the event of one panel being broken.
- Less wind resistance**
Stands strong against strong wind, can reduce the requirements for light pole strength.
- Easy installation and well-adapted**
Suitable for all types of extreme environments, such as high latitude areas, sandy areas, desert areas and seaside, etc.

VertHex Solar Power System



Specifications

Model No.	VSPV150W22-280	VSPV230W38-280
Physical Parameters		
Peak Power/Pm (W)(Expand flat power)	156	230
Peak Power/Pm (W)(Vertical service power)	78	116
Max. Power Voltage/Vmp (V)	23.4	37.6
Max. Power Current/Imp (A)	3.36	3.09
Open Circuit Voltage/Voc (V)	25.87	44.2
Short Circuit Current/IsC (A)	3.88	3.29
Solar Cells Efficiency	Around 23%	Around 23%
Grade of Solar Cells	A Grade	A Grade
Solar Cells Origin	China	China
Output Tolerance (Pm)	±5%	±5%
Solar Cell / No. of Cells and Connections	monocrystalline/38*6-cell in series	monocrystalline/50*6-cell in series
Operating Temperature Range	-40°C~+85°C	-40°C~+85°C
Max. System Voltage	1000V(TUV)/600V(UL)	1000V(TUV)/600V(UL)
TKVoltage (%/K)	-0.36	-0.36
TKCurrent (%/K)	0.07	0.07
TKPower (%/K)	-0.38	-0.38
Demension of Product (mm)	1316(L)×280(W)×240(T)	1898(L)×280(W)×240(T)
Net Weight of Product (kg)	16.5	22
Packing Parameters		
Main Package Carton Size(mm)	1385(L)×330(W)×300(T)	1968(L)×330(W)×300(T)
Main Package Gross Weight (kg)	19	25
Solar Panel Material List		
Front cover(material/thickness)	Low-iron tempered glass / 3.2mm	
EVA	High light transmittance, anti-oxidation, anti-corrosion	
Transparent TPE(Black)	High temperature resistance, fatigue resistance, creep resistance, impact resistance, transmittance	
Aluminum frame(AL6063,ADC12)	High tension resistance, corrosion resistance, abrasion resistance	
Packing Parameters		
EPA(effective projected area) (ft ²)	4.76	6.86
APA (acutal projected area) (ft ²)	3.97	5.72
Wind Load Rate (mph)	160	160
Install Dimensioent (mm)	60~171(Side 143mm)	60~171(Side 143mm)

MPPT Controller

Ultra-Intelligent



PRODUCT FEATURES

LEADSUN's independently developed MPPT controller offers flexible access and multiple charging modes. It provides a charging efficiency approximately 40% higher than PWM controllers. With a constant voltage charging function, it prevents impact damage to the battery during charging process. The controller is compatible with both 12V and 24V systems.

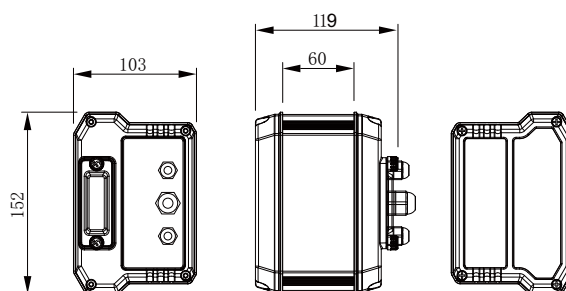

Model No.	VSMC220W12	VSMC400W24
Controller Parameters		
Max PV Input Power (W)	220	400
PV Input Voltage (V)	18	36
PV Input Voltage Range (V)	18~30	30~48
Battery Voltage (V)	12	24
Battery Voltage Range (V)	11.5~14.4	23~28.8
Max Charge Current (A)	15	14
Max MPPT Charge Efficiency	98%	98%
Max LED Power (W)	100	120
Number of LED	2	2
Single LED Max Power (W)	50	60
LED Voltage (V)	24	36
Wireless Type	LORA	LORA
PIR Function	Yes	Yes
Number of Batteries	2	2
Operating Temperature	-20°C~60°C	-20°C~60°C
Packing Parameters		
Demension of unit (mm)	152×103×119	152×103×119
Net Weight of Product (kg)	0.9	0.9
Demension of Carton (mm)/*4Set	380×280×200	380×280×200
Gross Weight of Package (kg)	5	5

MPPT Controller with Battery



At the heart of every Leadsun solar lighting system are the ingenious Lithium LiFePO4 batteries featuring LEADSUN's patented advanced battery management system. They have much greater charging efficiency and also provide double the lifespan compared to traditional solar lighting batteries. The battery cycle life is up to 2000 times at 100% DOD. MPPT controller can be integrated with battery.

-  Light Weight
-  Eco-Friendly
-  Stable Performance
-  Long Life Span
-  Safe and Explosion-proof
-  High Temperature Resistance

PHYSICAL DIMENSIONS (mm)

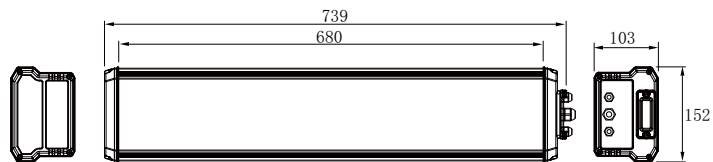

VSBY082012-MC

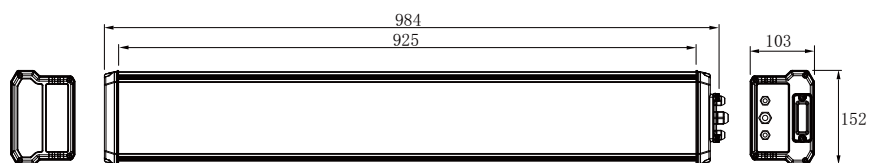

VSBY122912-MC

MPPT Controller with Battery

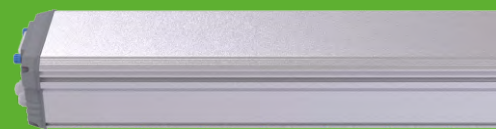

Specifications

Model No.	VSBY082012-MC	VSBY122912-MC
Battery Parameters		
Battery Capacity (Wh)	820	1229
Standard Voltage (V)	12.8	12.8
Types of Batteries	26700/4000mA/3.2V/Lithium iron phosphate battery	
Number of Batteries (pcs)	64	96
Max. Charging Voltage (V)	22	22
Min. Charging Voltage (V)	14.5	14.5
Max. Charging Current (A)	20	20
Charge Conditions	Cut-off Voltage (V)	14.4
	Cut-off Current (A)	0.1
Discharge Cut-off Voltage (V)	9.6	9.6
Max. Discharge Current (A)	20	20
Cycle Life (≥80% Capacity)	2000 times	2000 times
Design Life (1 cycle per day)	5 years	5 years
Certification	CB(IEC62133) / UN38.3 Transport certificate / EMC / ROHS	
Charge Temperature	0°C~51°C	0°C~51°C
Charge Temperature	-20°C~60°C	-20°C~60°C
Charge Temperature	-20°C~45°C	-20°C~45°C
Controller Parameters		
Max PV Input Power (W)	220	220
PV Input Voltage Range (V)	18~30	18~30
Max Charge Current (A)	15	15
Max MPPT Charge Efficiency	98%	98%
Max LED Output Power (W)	100	100
LED Output Voltage (V)	24	24
LED Open Circuit Voltage (V)	42	42
Number of LED Drives	2	2
Wireless Type (Optional)	LORA	LORA
PIR Function	Yes	Yes
Number of Batteries	2	2
Operating Temperature	-20°C~80°C	-20°C~80°C
Packing Parameters		
Net Weight of Product (kg)	10	15
Demension of unit (mm)	739×152×103	984×152×103
Gross Weight of Package (kg)	11	16.5
Demension of Carton (mm)/ *1Set	756×200×160	1016×200×160

LITHIUM-ION Battery Pack (LiFePO4)



Long Battery Life

LiFePO4 battery has 2,000+ charge cycles at 100% DOD. This means fewer battery replacements.



More Safety

Built-in BMS, automatic protection system to prevent over-charge, over-discharge, over-current and over-temperature.



Light Weight

Approximately 40% ~50% of the weight of the lead-acid battery.



Simplified Operations

Without complicated charging process, opportunistic charging will not shorten battery life. Drop-in replacement of lead-acid batteries.

CB CE FC UN38.3  

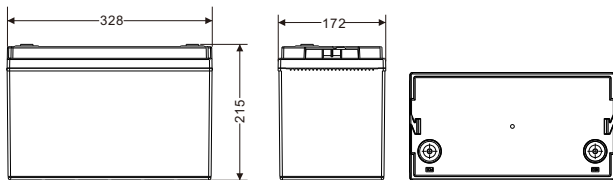

Model No.

VSBY153612-LP

Electrical Parameters

Nominal Voltage	12.8V
Nominal Capacity	120Ah@0.2C
Energy	1536Wh
Internal Resistance	45≤mΩ
Cycle Life	2000-3000 (Cycle Life @ 100% Depth of Discharge)
Self Discharge	<3.5% (Monthly@25°C)

Standard Charge

Charging Voltage	14.0~14.6V
Charging Mode	Charging mode in 0°C~45°C environment, 0.2C5A constant current charge to 14.6V, then 14.6V constant voltage charge until the current drops to 0.02C5A and then stop
Charging Current	20A
Max Charging Current	50A

Standard Discharge

Discharging Current	20A
Max Continuous Discharging Current	100A
Max Pulse Discharging Current	200A(<3S)
Discharging Cut-off Current	10.0A

Operation and Storage

Charge Temp.	0°C to 45°C (32°F to 113°F) @60±25% humidity
Discharge Temp.	-20°C to 60°C (-4°F to 140°F) @60±25% humidity
Storage Temp.	0°C to 45°C (32°F to 113°F) @60±25% humidity
IP Class	IP55

Physical Parameters

Battery Cells Type & Arrangement	IFR32140 , 4S8P
Housing Material	ABS
Dimension (L×W×H)	328×172×215mm
N.Weight	13.1kg
Terminal Type	M8

Freedom Classic LED Street Light

CE | IP66 | IK08



Using high-efficiency LED, luminous efficiency is up to 180lm/W (@25 C). The lights sealing lens is made of strong anti-ultraviolet PC, which has anti-aging and anti-impact performance, enabling long term usage. With the unique cutoff design of the optic lens, allows us to eliminate the lighting pollution to the environment.

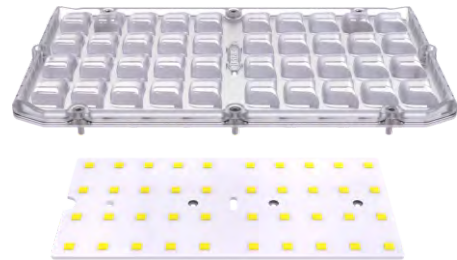

PIR Motion Detection System

PIR motion detection system that automatically regulate the light source from full bright to dim mode to increase battery autonomy.

100% Brightness when motion is detected

30% Brightness when no motion is detected

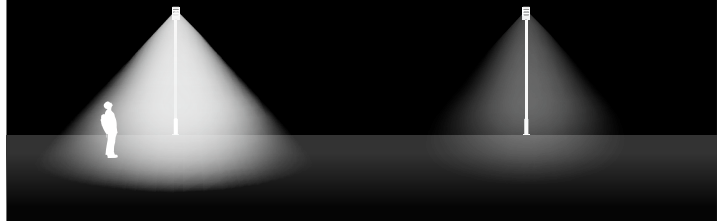

PHYSICAL DIMENSIONS (mm)

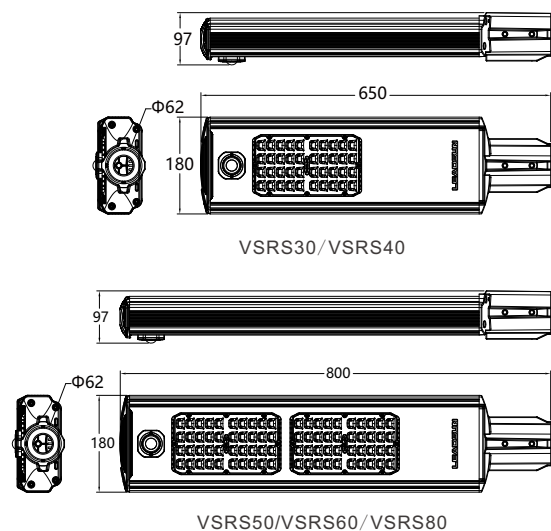

Freedom Classic LED Street Light



LIGHT DISTRIBUTION

The new lens design improves the lighting effect and the high quality optics and precision engineering of the lens provide options of T2/T3/T2L IES lighting distribution patterns, other benefits include increased uniformity and comfort. Dark Sky certificated luminaires are optional.

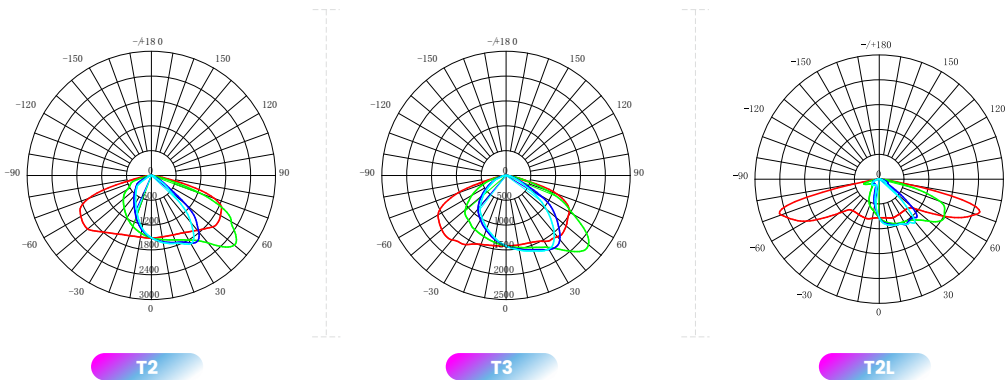

SPECIFICATIONS

Model No.	VSRS30	VSRS40	VSRS50	VSRS60	VSRS80
Light Parameters					
Light Output (W)	30	40	50	60	80
Optional Light Distribution	T2/T3/T2L	T2/T3/T2L	T2/T3/T2L	T2/T3/T2L	T2/T3/T2L
Color Temperature (K)	3000/4000/5000	3000/4000/5000	3000/4000/5000	3000/4000/5000	3000/4000/5000
Typical Luminous Flux (lm) (5000K)	5550	7200	9500	11800	14800
Physical Parameters					
Qty. of LED Chips	36	36	2×36	2×36	2×36
Motion Sensor	PIR / DISS	PIR / DISS	PIR / DISS	PIR / DISS	PIR / DISS
Range of input Voltage (V)	22V	22V	22V	22V	22V
Storage Temperature	-20°C~45°C	-20°C~45°C	-20°C~45°C	-20°C~45°C	-20°C~45°C
Dimension of Product (mm)	650×180×97	650×180×97	800×180×97	800×180×97	800×180×97
Net Weight of Product (kg)	3.2	3.2	3.2	4	4
Packing Parameters					
Dimension of Carton (mm)*2Set	680×240×210	680×240×210	830×240×210	830×240×210	830×240×210
Gross Weight of Product (kg)	8	8	10	10	10
Mounting Recommendation					
EPA (Effective projected area) (ft ²)	0.57	0.57	0.70	0.70	0.70
APA (Acutal projected area) (ft ²)	0.47	0.47	0.58	0.58	0.58
Wind Load Rate (mph)	160	160	160	160	160
Recommended Installation Height (m)	5~8	5~8	7~10	7~10	10~12
Recommended Installation Distance (m)	30~55	30~55	45~70	45~70	70~90
Top of Pole or Tenon OD (mm)	60	60	60	60	60

Freedom Plus LED Street Light

IP66 | IK08 | 3 Years
Warranty

Incorporating a brilliant LED street light, smart LiFePO4 battery system, high efficiency controller and strong aluminium alloy cage, the Freedom Plus series provides a reliable and cost-effective solution for solar street lighting. With outstanding features of long life span, simple installation and low cost maintenance, the Freedom Plus series is indeed a classic work which can meet the needs of users.



PIR Motion Detection System

PIR motion detection system that automatically regulate the light source from full bright to dim mode to increase battery autonomy.

100% Brightness when
motion is detected

30% Brightness when
no motion is detected

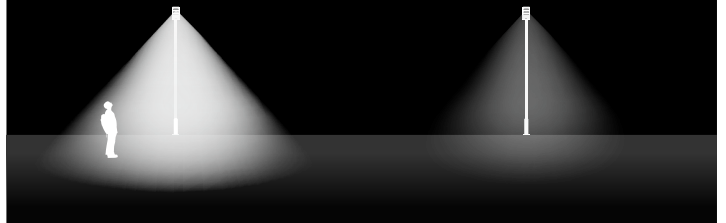

PHYSICAL DIMENSIONS (mm)

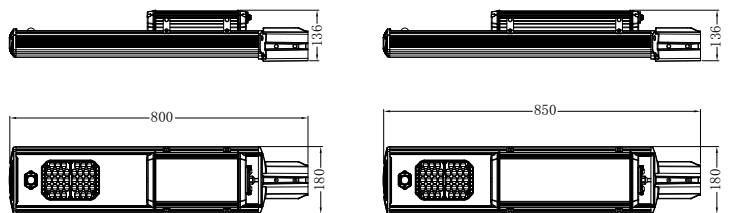

UP20L

UPG40P

Freedom Plus LED Street Light



LIGHT DISTRIBUTION

The new lens design improves the lighting effect and the high quality optics and precision engineering of the lens provide options of T2 & T3 IES lighting distribution patterns, other benefits include increased uniformity and comfort.

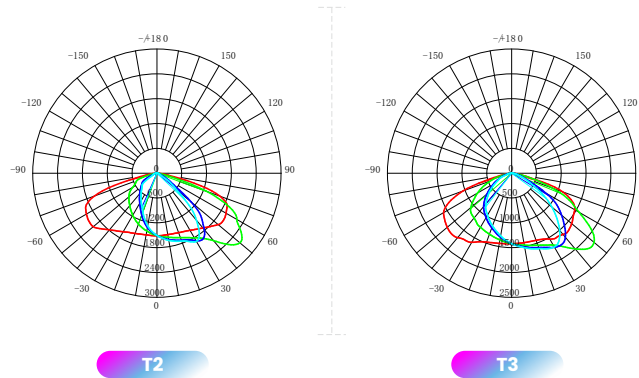

SPECIFICATIONS

Model No.	UP20L	UPG40P
Light Parameters		
Light Output (W)	20	40
Optional Light Distribution	T2/T3	T2/T3
Color Temperature (K)	3000/4000/5000	3000/4000/5000
Typical Luminous Flux (lm)(5000K)	3800	7200
Working Mode	Full brightness when detected, 30% brightness when no motion detected	
Min. Working Time (Hours)	Bright Mode 9 DIM Mode (30%) 29	9 29
Physical Parameters		
Liuthium Battery Capacity (Wh)	205	410
Qty. of LED Chips	16	36
Motion Sensor	PIR	PIR
Dimension of Product (mm)	800×180×136	850×180×136
Net Weight of Product (kg)	10	12
Packing Parameters		
Dimension of Carton (mm)*2Set	855×170×230	910×190×240
Gross Weight of Product (kg)	12	14
Environment Requirement		
Charge Temperature	0°C~51°C	0°C~51°C
Discharge Temperature	-20°C~60°C	-20°C~60°C
Storage Temperature (<3 months)	-20°C~45°C	-20°C~45°C
Storage Temperature (3~12 months)	-20°C~25°C	-20°C~25°C
Mounting Recommendation		
EPA (Effective projected area) (ft ²)	0.70	0.73
APA (Acutal projected area) (ft ²)	0.58	0.60
Wind Load Rate (mph)	130	130
Recommended Installation Height (m)	4~7	5~8
Recommended Installation Distance (m)	15~25	20~30
Top of Pole or Tenon OD (mm)	60	60

XL series (Bell-shaped) LED Street Light

CE | IP66 | IK08



XL series, a retro bell-shaped luminaire is compatible with various solar panel power supply systems. Its sleek and simple design prevents dust buildup when used outdoors. The internal space can accommodate batteries to meet diverse customer application requirements. It can be used with a variety of optical lenses.

PIR Motion Detection System

PIR motion detection system that automatically regulate the light source from full bright to dim mode to increase battery autonomy.

100% Brightness when motion is detected

30% Brightness when no motion is detected

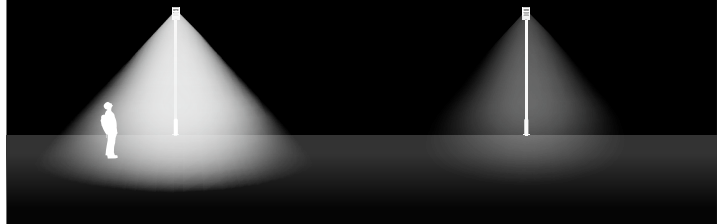

PHYSICAL DIMENSIONS (mm)

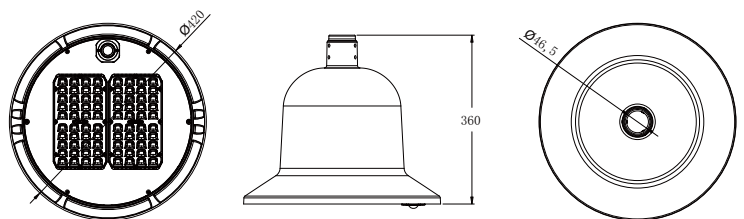

XL series (Bell-shaped) LED Street Light



LIGHT DISTRIBUTION

The new lens design improves the lighting effect and the high quality optics and precision engineering of the lens provide options of T2/T3/T2L IES lighting distribution patterns, other benefits include increased uniformity and comfort.

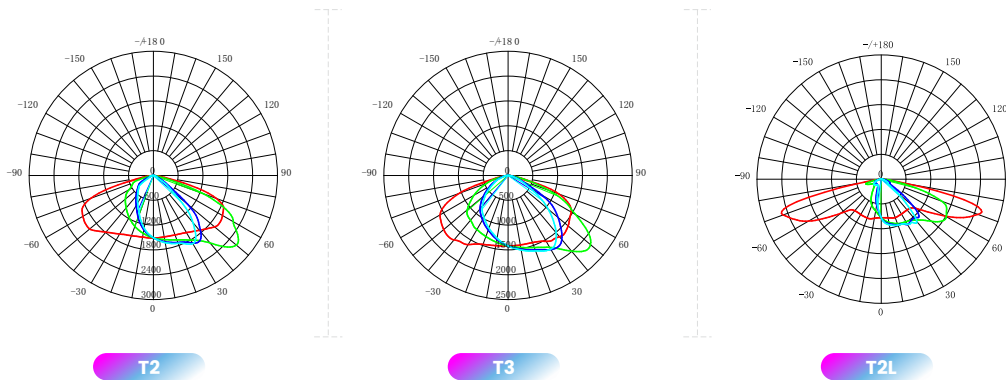

SPECIFICATIONS

Model No.	VSBL30	VSBL40	VSBL50	VSBL60	VSBL80
Light Parameters					
Light Output (W)	30	40	50	60	80
Light Distribution	T2/T3/T2L	T2/T3/T2L	T2/T3/T2L	T2/T3/T2L	T2/T3/T2L
Color Temperature (K)	3000/4000/5000	3000/4000/5000	3000/4000/5000	3000/4000/5000	3000/4000/5000
Typical Luminous Flux (lm)(5000K)	5550	7200	9500	11400	14800
Physical Parameters					
Qty. of LED Chips	36	36	2×36	2×36	2×36
Motion Sensor	PIR/DISS	PIR/DISS	PIR/DISS	PIR/DISS	PIR/DISS
Range of input Voltage (V)	22	22	22	22	22
Storage Temperature	-20°C~45°C	-20°C~45°C	-20°C~45°C	-20°C~45°C	-20°C~45°C
Net Weight (kg)	4.5	4.5	5	5	5
Dimension of unit (mm)	Ø420×360	Ø420×360	Ø420×360	Ø420×360	Ø420×360
Packing Parameters					
Dimension of Carton (mm)	500×500×400	500×500×400	500×500×400	500×500×400	500×500×400
Gross Weight of Product (kg)	6.5	6.5	7	7	7
Mounting Recommendation					
EPA (Effective projected area) (ft ²)	1.95	1.95	1.95	1.95	1.95
APA (Acutal projected area) (ft ²)	1.63	1.63	1.63	1.63	1.63
Wind Load Rate (mph)	160	160	160	160	160
Recommended Diameter of arm (mm)	Ø42	Ø42	Ø42	Ø42	Ø42
Recommended Installation Height (m)	5~8	5~8	7~10	7~10	8~12
Recommended Installation Distance (m)	20~30	20~30	25~40	30~45	35~45

V-shaped Luminaire LED Garden Light



The V-shaped LED garden light is a cutting-edge luminary. Its design is a harmonious blend of simplicity and elegance, with an ergonomic touch that complements its functionality. Ideal for installation on poles ranging from 3 to 12 meters, it aptly illuminates both wide and narrow bicycle paths, parking lots, parks, highways, and various other outdoor spaces.

PHYSICAL DIMENSIONS (mm)

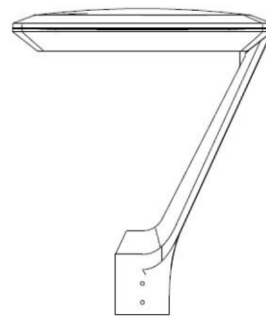
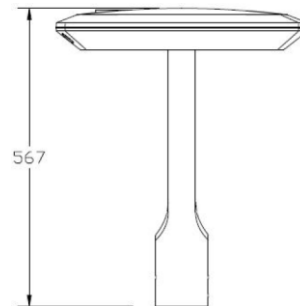
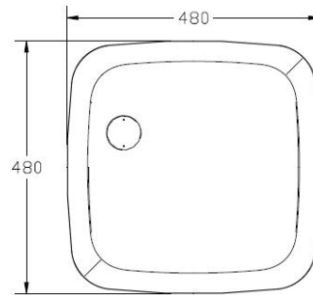

V-shaped Luminaire LED Garden Light



LIGHT DISTRIBUTION

The new lens design improves the lighting effect and the high quality optics and precision engineering of the lens provide options of T2 & T3 IES lighting distribution patterns, other benefits include increased uniformity and comfort.

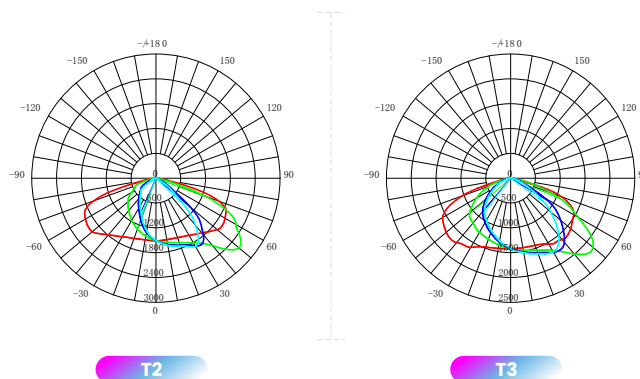

SPECIFICATIONS

Model No.	VSVL30	VSVL40	VSVL50	VSVL60	VSVL80
Light Parameters					
Light Output (W)	30	40	50	60	80
Optional Light Distribution	T2/T3	T2/T3	T2/T3	T2/T3	T2/T3
Color Temperature (K)	3000/4000/5000	3000/4000/5000	3000/4000/5000	3000/4000/5000	3000/4000/5000
Typical Luminous Flux (lm) (5000K)	5550	7200	9500	11400	14800
Physical Parameters					
Qty. of LED Chips	36	36	2×36	2×36	2×36
Motion Sensor	/	/	/	/	/
Range of input Voltage (V)	22V	22V	22V	22V	22V
Storage Temperature	-20°C~45°C	-20°C~45°C	-20°C~45°C	-20°C~45°C	-20°C~45°C
Dimension of Product (mm)	567×480×480	567×480×480	567×480×480	567×480×480	567×480×480
Net Weight of Product (kg)	9	9	9.5	9.5	9.5
Packing Parameters					
Dimension of Carton (mm)*2Set	620×520×525	620×520×525	620×520×525	620×520×525	620×520×525
Gross Weight of Product (kg)	11	11	11.5	11.5	11.5
Mounting Recommendation					
EPA (Effective projected area) (ft ²)	1.24	1.24	1.24	1.24	1.24
APA (Acutal projected area) (ft ²)	1.03	1.03	1.03	1.03	1.03
Wind Load Rate (mph)	160	160	160	160	160
Recommended Installation Height (m)	5~8	5~8	7~10	7~10	8~12
Recommended Installation Distance (m)	20~30	20~30	25~40	30~45	35~45
Top of Pole or Tenon OD (mm)	Ø76	Ø76	Ø76	Ø76	Ø76